

№	Артикул	Наименование	Кол-во
1	SX-11-008EVO	Heating handle sleeve	2
2	NF-002-R-BEVO	Welding assembly -B right handrail	1
3	2012-SX-11-031-2EVO	the right handle welding	1
4	SX-11-36B-3EVO	walk cable	1
5	HFN-8EVO	Flange surface nut	1
6	11-SX-11-36KEVO	Handle self-locking cable	1
7	NHLN-6EVO	Non metal outside six angle locknut	4
8	NF-001-8EVO	Gear plate welding assembly	1
9	SW-8EVO	spring washer	2
10	NF-001-13-2EVO	The walking gear extension rod	1
11	SX-11-036B-2EVO	auger cable	1
12	NJ-01EVO	The output shaft bolt	2
13	NJ-02EVO	Pin buckle	2
14	NF-001-5-02EVO	Panel below plate	1
15	NF-010EVO	panel	1
16	BE-4*12EVO	Blindniete	4
17	SA-011EVO	switch	2
18	NF-001-15EVO	Gear plate	1
19	FB-5*12*1EVO	Flat washer	14
20	SHSS-4.8*16EVO	The pan head tapping screws	12
21	NF-001-4-01EVO	Gear rack	1
22	HS-6*12EVO	Six outer hexagon bolt	4
23	STG8062Ae-26EVO	The gear handle	2
24	NF-001-13EVO	Chute gear extension rod	1
25	FB-8*22*2EVO	Flat washer	4
26	SJ-209EVO	The adjusting rod welding assembly	1
27	2012-KEY-04EVO	Self-locking fixing seat	1
28	FB-8*16*1.2EVO	Flat washer	8
29	SW-6EVO	spring washer	2
30	HS-6*18EVO	Six outer hexagon bolt	3
31	SX-11-31-4EVO	The left clutch handle	1
32	SJ-047-12EVO	SJ rubber cap	2
33	NF-002-L-BEVO	The left armrest pipe welding assembly	1
34	FB-6*12*0.7EVO	Flat washer	1
35	SJ-046-1EVO	Small tensioning plate pad	4
36	HS-8*55EVO	Six outer hexagon bolt	2
37	HFB-8*40EVO	The six angle flange screws	3
38	HS-8*50EVO	Six outer hexagon bolt	1
39	SJ-233EVO	Pull pin	1
40	NF-001-14-3BEVO	The clutch handle tension spring	1
41	NHLN-8EVO	Non metal outside six angle locknut	9
42	SX-11-36EEVO	Chute cable	1
43	HS-10*45EVO	Six outer hexagon bolt	1
44	NF-001-4-02EVO	Gear rack	1
45	FB-10*28*3EVO	Flat washer	1
46	GPP6562C-01-07EVO	Speed control handle connector	1
47	OSP-2.5*25EVO	cotter pin	1
48	GPP6562C-01-09EVO	Speed adjusting spring 1	1
49	NF-001-7EVO	Chute gear fixed frame left	1
50	STG11 (13) 70 (10) AE-02-02-08EVO	The regulating spring	1
51	L-620EVO	lamp	1
52	STG8062AE-22EVO	lamp bracket	1
53	CHSS-3.2*30EVO	Cross recessed countersunk head tapping screws	4
54	NHLN-10EVO	Non metal outside six angle locknut	1
55	HS-8*45EVO	Six outer hexagon bolt	3
56	OSP-2.0*29EVO	cotter pin	1
57	NF-001-7-01EVO	Chute gear fixed frame right	1
58	SJ-223EVO	Bowl shrapnel	1
59	SA-008EVO	Saddle shaped elastic gasket	3
60	SJ-224EVO	Gourd-shaped card	2
61	SJ-215EVO	U card	2
62	SJ-210-1EVO	Adjustable damping mounting plate 1	1

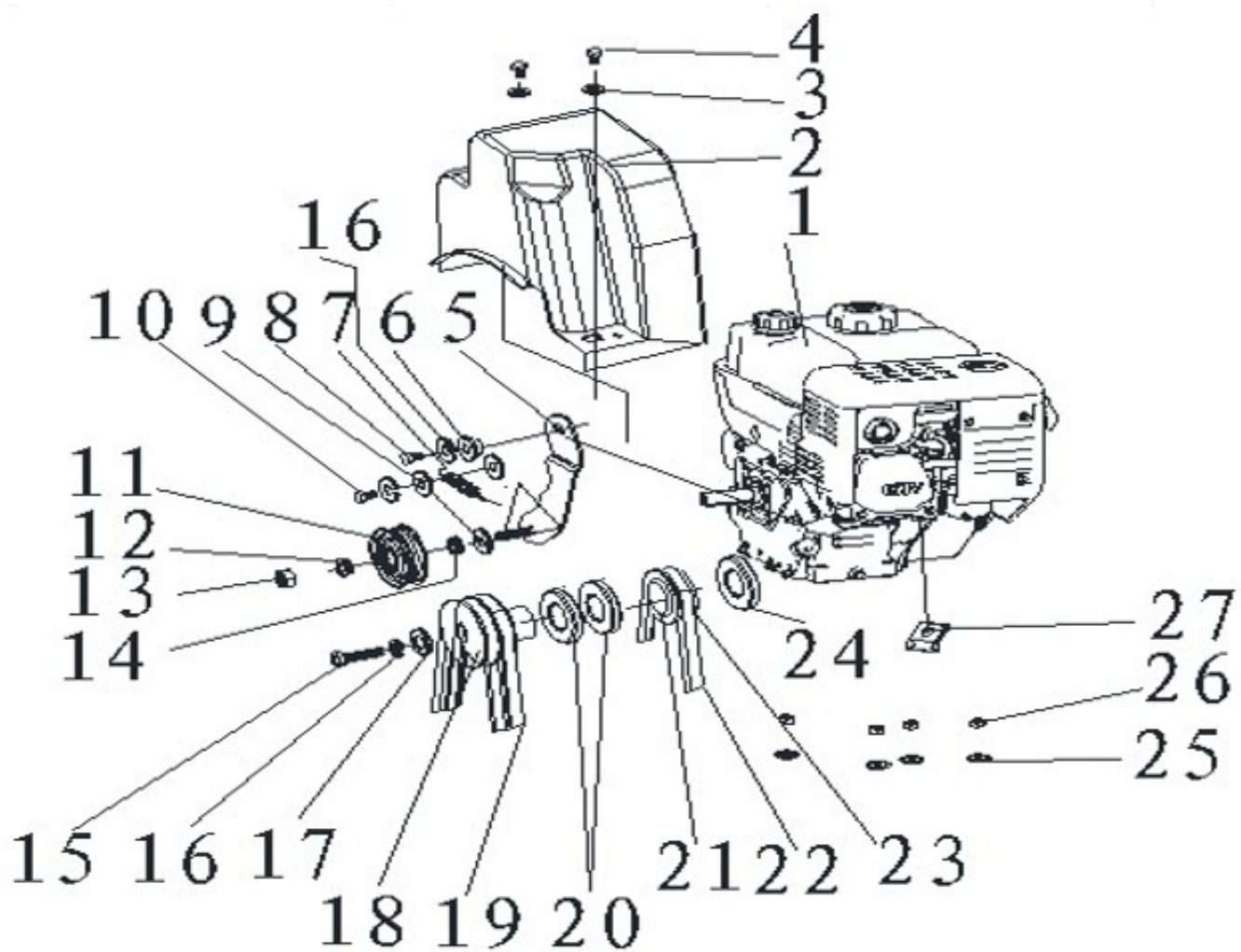

№	Артикул	Наименование	Кол-во
1		Engine	1
2	SX-11-180EVO	The belt wheel cover	1
3	FB-6*16*1.5EVO	Flat washer	2
4	HS-6*12EVO	hexagon screw	2
5	SX-11-173EVO	Small tensioning plate	1
6	SJ-046EVO	Small tensioning plate pad	1
7	STG11(13)70(10)AE-02--01-19-01EVO	Small tensioning wheel spring	1
8	HS-8*20EVO	hexagon screw	1
9	FB-8*16*1.2EVO	Flat washer	2
10	HS-8*20EVO	hexagon screw	1
11	SX-11-170EVO	small tension wheel	1
12	SX-11-170BEVO	Cushion Cover	1
13	NHLN-8EVO	Non metal outside six angle locknut	1
14	SJ-008CEVO	SJ gasket	1
15	HS-8*35EVO	hexagon screw	1
16	SW-8EVO	spring washer	3
17	FB-8*28*3EVO	Flat washer	1
18	STG11(13)70(10)AE-02-04-10EVO	The main belt pulley	1
19	LB4L-960EVO	V Belt	2
20	FB-25*35*5EVO	Flat washer	1
21	SX-11-168CEVO	The small pulley washer	1
22	TB-5M*825EVO	Timing belt 5M	1
23	SX-11-168bEVO	Main synchronous wheel	1
24	FB-25*35*2EVO	Flat washer	1
25	NHLN-10EVO	Non metal outside six angle locknut	4
26	FB-10*20*2EVO	Flat washer	4
27	FD-04-62EVO	cable bracket	1

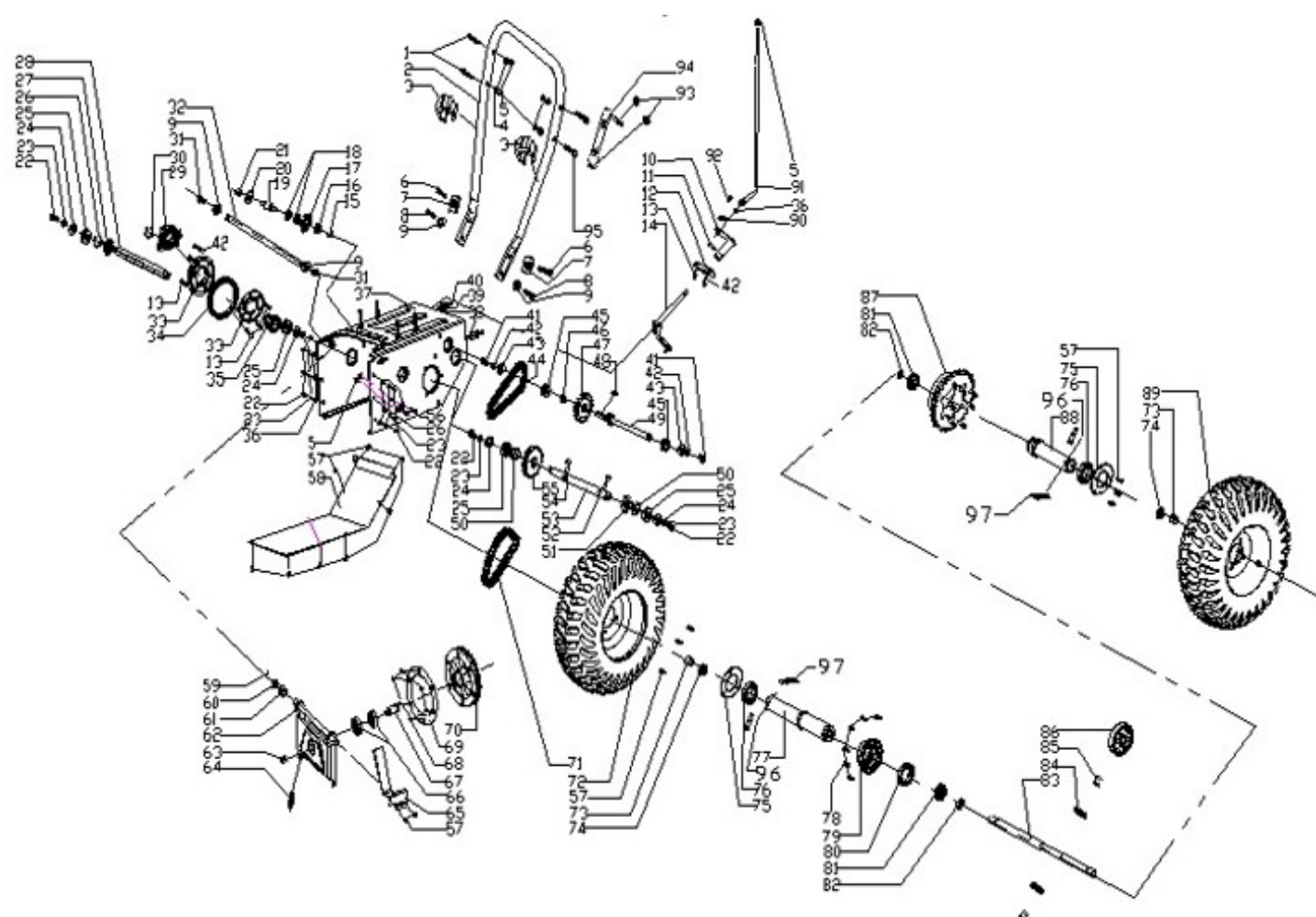

№	Артикул	Наименование	Кол-во
1	NS-L8*40EVO	screw bolt	2
2	STG11(13)70(10)AE-02-02-10EVO	Under the armrest tube	1
3	SSG5580A.23-01EVO	fastener	2
4	BG-8EVO	Spacer	4
5	HFN-8EVO	Flange surface nut	7
6	HS-10*40EVO	Six angle screw	2
7	FD-04-54EVO	Spacer	2
8	HS-10*20EVO	Six angle screw	2
9	FB-10*20*2EVO	flat gasket	2
10	STG11(13)70(10)AE-02-02-03EVO	The shifting fork arm	1
11	FRP-6*30EVO	Coiled elastic pin	1
12	SX-11-148EVO	Rectangular block	1
13	HS-6*12EVO	Six angle screw	8
14	STG11(13)70(10)AE-02-02-02EVO	Fork plate combination	1
15	NHLN-10EVO	Non metal outside six angle locknut	1
16	FB-10*20*2EVO	flat gasket	1
17	STG11(13)70(10)AE-02-01-15EVO	tightener sprocket	1
18	BE-6001EVO	deep groove ball bearing	2
19	STG11(13)70(10)AE-02-01-14EVO	The tension chain wheel	1
20	FB-12*24*2EVO	flat gasket	2
21	NHLN-12EVO	Non metal outside six angle locknut	1
22	HFB-8*20EVO	The six angle flange screws	8
23	SW-8EVO	spring washer	8
24	FB-8*28*2EVO	flat gasket	4
25	KBE-6203EVO	With stop clamping spring deep groove ball bearing	2
26	SR-17EVO	Shaft circlip	1
27	SX-11-183EVO	sprocket wheel	1
28	STG11(13)70(10)AE-02-01-08EVO	shaft	1
29	SJ-013BEVO	Gear wheel cover	1
30	SR-35EVO	Shaft circlip	1
31	HS-10*16EVO	Six outer hexagon bolt	2
32	STG1310AE-02-01-07-01EVO	The connecting shaft	1
33	SJ-013AEVO	Gear wheel washer	2
34	SJ-013DEVO	Rubber ring gear	1
35	SJ-013CEVO	Gear wheel set	1
36	FB-8*16*1.2EVO	flat gasket	9
37	STG11(13)70(10)AE-02-01-01EVO	Transmission box	1
38	NHLN-5EVO	Non metal outside six angle locknut	2
39	FB-5*16*1.2EVO	flat gasket	4
40	HFB-5*16EVO	The six angle flange bolts	2
41	HS-6*16EVO	Six outer hexagon bolt	2
42	SW-6EVO	spring washer	8
43	FB-6*23*3EVO	flat gasket	2
44	C-08A-051EVO	chain	1
45	KBE-6202EVO	deep groove ball bearing	2
46	SR-15EVO	Shaft circlip	1
47	STG11(13)70(10)AE-02-01-10EVO	sprocket wheel	1
48	FK-A5*12EVO	flat key	1
49	STG11(13)70(10)AE-02-01-09EVO	shaft	1
50	SW-20EVO	Shaft circlip	2
51	STG11(13)70(10)AE-02-01-12EVO	sprocket wheel	1
52	FK-A5*18EVO	flat key	1
53	STG11(13)70(10)AE-02-01-11EVO	Third axis	1
54	FK-A6*20EVO	flat key	1
55	STG11(13)70(10)AE-02-01-13EVO	Third shaft gear	1
56	HS-8*40EVO	Six outer hexagon bolt	2
57	ZHFB-6*12EVO	The six angle flange self-tapping bolt	14
58	STG11(13)70(10)AE-02-01-17EVO	The box cover	1
59	CP-3*25EVO	cotter pin	1
60	FB-13*24*2EVO	flat gasket	2
61	STG11(13)70(10)AE-02-01-16EVO	The pulley bracket sleeve	1
62	STG11(13)70(10)AE-02-01-18EVO	pulley support	1
63	NHLN-10EVO	Non metal outside six angle locknut	1
64	SJ-035EVO	Wheel bracket spring	1
65	SX-11-149-2EVO	The pulley plate 1	1
66	BE-6203EVO	deep groove ball bearing	2
67	SJ-010BEVO	Drive shaft pulley	1
68	CHS-6*8EVO	Cross recessed countersunk head screws	4
69	SJ-010A-1EVO	SJ drive synchronous wheel cover	1
70	SJ-010AEVO	SJ drive synchronous pulley	1
71	C-10A-036EVO	Third axle chain	1
72	STG1170AE-02-04-05EVO	tire	2
73	STG11(13)70(10)AE-02-01-03EVO	Differential shaft sleeve	2
74	BE-61804EVO	deep groove ball bearing	2
75	GPG65500A-01-02-05EVO	75 stifle	2
76	BE-6009EVO	deep groove ball bearing	2
77	STG11(13)70(10)AE-02-01-05EVO	The differential right axis	1
78	HES-6*12EVO	Hexagon socket head cap screw	12
79	GPG65500A-11-01-02EVO	Differential wheel sets	1
80	BE-6909EVO	deep groove ball bearing	2
81	GPG65500A-11-03-01EVO	The differential bevel gear 13	2
82	GPG65500A-06-01-03EVO	Spacer sleeve	2
83	GPG65500A-11-003-01EVO	The differential shaft	1
84	GPG65500A-11-03EVO	The differential bevel gear rack	1
85	GPG65500A-11-06EVO	The differential bevel gear shaft	2
86	GPG65500A-11-03-02EVO	The differential bevel gear 12	2
87	GPG65500A-11-01EVO	The differential sprocket assembly (left)	1
88	STG11(13)70(10)AE-02-01-04EVO	The differential left axis	1
89	STG1170AE-02-04-05EVO	tire	1
90	CP-2.0*29EVO	The opening pin	1
91	NF-007-17EVO	Gear connecting rod	1
92	GPP6562C-01-09EVO	Speed adjusting spring 1	1
93	SJ-011AEVO	SJ mounting plate plastic ring	2
94	NF-19EVO	Rocker fixed frame 2	1
95	HFB-8*45EVO	The six angle flange bolts	2
96	STG1170AE-02-04-35EVO	The wheel bolt	2
97	NJ-02EVO	Pin buckle	2

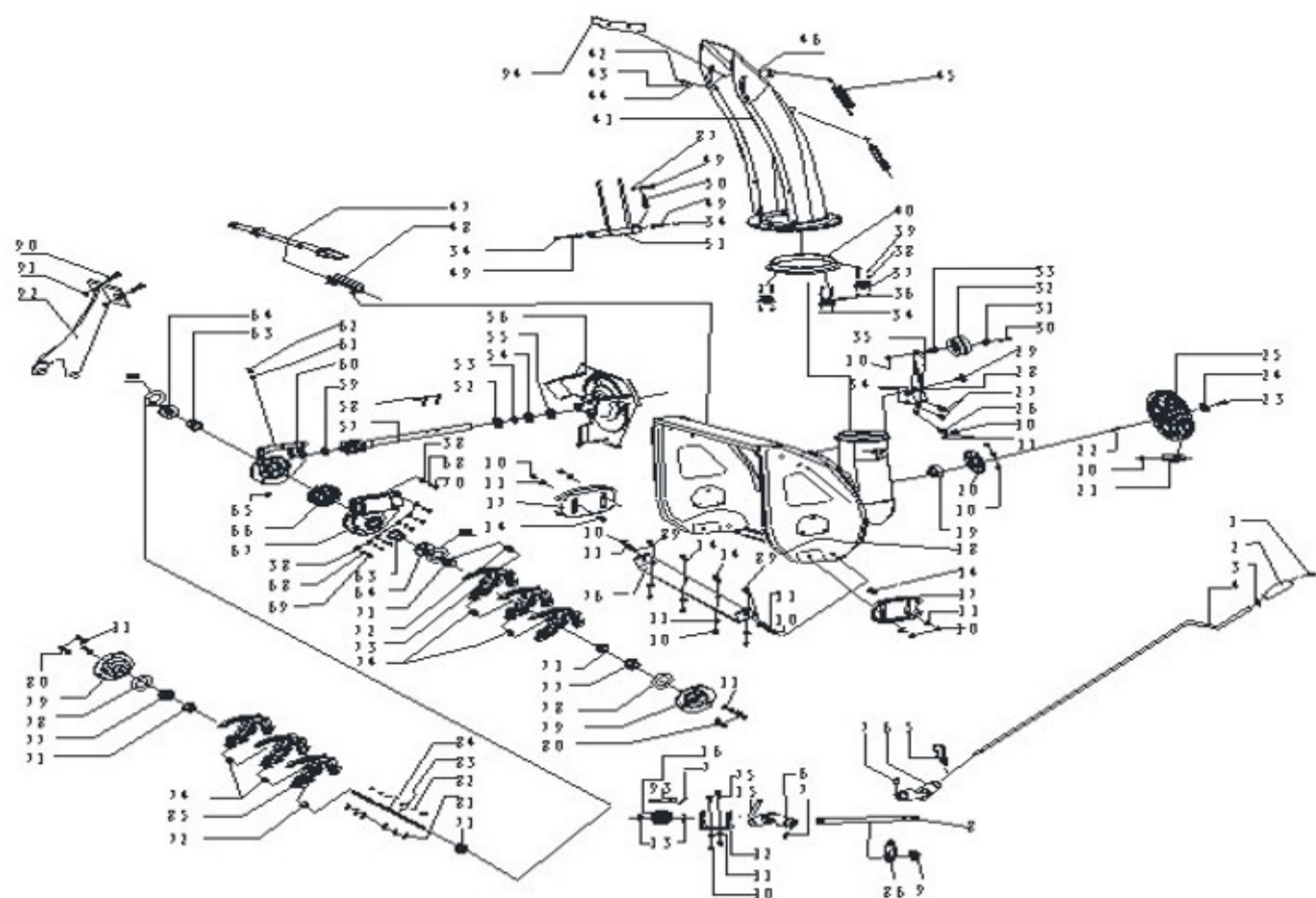

№	Артикул	Наименование	Кол-во
1	HFB-6*12EVO	Flange six hexagon bolt	1
2	SJ-018EVO	SJ hand set	1
3	FB-10*20*1.5EVO	flat gasket	1
4	NF-SX-11-075-1EVO	Chute rocker	1
5	STG11(13)70(10)AE-02-01-020EVO	cross-pin	1
6	SX-11-257EVO	universal joint	2
7	OSP-4*16EVO	The elastic cylindrical pin	3
8	SX-11-084-1EVO	Chute rocker 1-2012	1
9	SJ-239EVO	Helical bracket rocker gasket	1
10	HL-8EVO	Six corners locknut	18
11	FB-8*16*1.2EVO	spacer	20
12	SX-11-259-2EVO	support-2012	1
13	SX-11-259-1EVO	Support washer -2012	2
14	CB-8*16EVO	Cup head square neck screw	4
15	CP-3.2*25EVO	cotter pin	3.2*25
16	SX-11-255-2EVO	helical gear-2012	1
17	SJ-111EVO	skid shoe	2
18	28-SX-11-189REVO	big shell	1
19	BE-SB204EVO	Spherical ball bearing	1
20	SJ-004EVO	Round bottom cover	1
21	STG1310AE-02-06-01EVO	Belt baffle	1
22	FK-(B)6*6*20 (16) EVO	flat key	1
23	HS-8*20EVO	Six angle screw	1
24	FB-8*28*2EVO	flat gasket	1
25	SX-11-140EVO	The big belt wheel	1
26	SJ-037EVO	spring 5	1
27	SJ-23-25EVO	bolt	2
28	SX-11-144-12EVO	The tensioning plate	1
29	SJ-050EVO	Six angle screw 1	1
30	HS-8*45EVO	Six angle screw	1
31	SJ-008CEVO	SJ pad	1
32	SJ-008EVO	Large pulley	1
33	SJ-008BEVO	Cushion	1
34	TB-6EVO	Non metal outside six angle locknut	10
35	FB-8*16*1.2EVO	flat gasket	2
36	SJ-021EVO	presser	3
37	SJ-021CEVO	spacer	6
38	FB-6*12*0.7EVO	flat gasket	13
39	HS-6*20EVO	Six angle screw	6
40	SJ-237EVO	Chute seat plastic ring	1
41	SX-11-106-12EVO	snow chute 2012	1
42	CPS-5*12EVO	Cross recessed pan head screw	1
43	SJ-200-08EVO	nylon spacer	2
44	TB-5EVO	Non metal outside six angle locknut	1
45	SJ-226EVO	Chute spring	1
46	SX-11-105-1EVO	snow chute cap 2012	1
47	SJ-150EVO	plastic shovel	1
48	SJ-151EVO	Shovel base	1
49	HS-6*16EVO	Six angle screw	3
50	SJ-036EVO	SJ spring 4	1
51	SJ-012EVO	Bent rod sleeve rod	1
52	RM-5HPEVO	Oil nipple	1
53	BE-6904EVO	deep groove ball bearing	1
54	SJ-057EVO	space ring	1
55	BE-51104EVO	One-way thrust ball bearing	1
56	PS-32*20*7EVO	oil seal	2
57	SJ-001EVO	fan	1
58	SX-11-114EVO	Worm gear shaft	1
59	FRP-6*30`EVO	Coiled elastic pin	2
60	BE-16001EVO	deep groove ball bearing	1
61	SJ-101EVO	pedestal	1
62	WG-8EVO	The fuel nozzle gasket	1
63	SJ-108EVO	The output shaft sleeve	2
64	OS-30*19*7EVO	oil seal	2
65	CPS-5*10EVO	Cross recessed pan head screw	1
66	SJ-038EVO	worm gear	1
67	SJ-101AEVO	upper pedestal	1
68	EP-6EVO	spring washer	7
69	HS-6*20EVO	Six outer hexagon bolt	6
70	HS-6*25EVO	Six outer hexagon bolt	1
71	SJ-019EVO	Drive shaft sleeve	12
72	28-SX-11-301EVO	The output shaft sleeve 28-2	2
73	30-SX-11-125EVO	right auger	3
74	28-SX-11-300EVO	The output shaft sleeve 28-1	4
75	CB-8*18EVO	half-round head square neck bolt	2
76	SX-11-132EVO	Long baffle	1
77	SJ-020EVO	axle sleeve	2
78	FB-19*38*1.5EVO	flat gasket	2
79	SJ-024EVO	bearing cap	2
80	HS-8*10EVO	Six outer hexagon bolt	6
81	NJ-01EVO	The output shaft bolt	6
82	NJ-02EVO	Pin buckle	6
83	28-SX-11-134EVO	The auger shaft	1
84	WK-5*7.5*19EVO	woodruff key	1
85	30-SX-11-135EVO	left auger	3
86	SX-11 (13) 70 (10) -02-01-19EVO	Chute rocker fixing frame	1
87	HFN-6EVO	The six angle flange surface nut	2
88	FB-19*38*0.6EVO	flat gasket	2
89	CB-8*20EVO	Cup head square neck screw	4
90	SX-11-84-3EVO	Chute helical rod -2012	1
91	SX-11-400EVO	Chute rubber pad -2012	1